

# AKU



Acoustically insulated fans

Caissons de ventilation insonorisés

Isolierte Rohrventilatoren

Канальные акустические вентиляторы



Acoustically insulated duct fans are made of galvanized steel. The fan casing has thermal and acoustic 50 mm insulation. These products can not be exploited in explosive environment. Fans can supply/extract clean air. Fans are mounted into the round air duct systems. For the AKU units are used centrifugal fans and motors with maintenance-free ball bearings. Fans with TK terminals have integrated thermo-contact protection of the motor. Fans have easily opening cover which ensures easy service. The maximum motor current and the rated power supply voltage. If the control voltage is reduced, motor current can exceed the rated current. Considering this, we recommend respective speed controllers for every fan. Acoustically insulated fans can be mounted only indoors.



Schallgedämmte Kanalventilatoren AKU bestehen aus verzinktem Stahlblech. Das Gehäuse der Ventilatoren ist mit einer 50 mm starken Isolation versehen, welche akustisch und wärmetechnisch isoliert. Diese Ventilatoren dürfen nicht in explosionsgefährdeter Umgebung installiert werden. Sie dienen der Be- und Entlüftung. Sie werden an runde Luftkanäle angeschlossen. Die AKU Geräte sind mit radialen Ventilatoren ausgerüstet, deren Lager keiner Aufsicht bedürfen. Die Elektromotoren sind mit PTC-Fühlern oder Thermokontakten zu deren Schutz versehen. Ventilatoren mit TK-Klemmen besitzen einen Thermokontakt. Dank ihrer guten Zugänglichkeit ist die Wartung der Ventilatoren einfach. Der Motoren-Nennstrom ist angegeben und darf nicht überschritten werden. Nur bei verringerter Steuerspannung darf der Nennstrom auch etwas darüber liegen. Wir empfehlen für jeden Ventilator den Einsatz eines Drehzahlreglers. AKU Ventilatoren sind nur innerhalb der Gebäude einzusetzen (nicht im Freien).









Les caissons de ventilation insonorisés AKU sont réalisés à partir de tôle galvanisée. L'enveloppe possède une isolation thermique et acoustique de 50 mm. Ces produits sont destinés à la ventilation d'air hygiénique et ne sont pas appropriés à un fonctionnement en environnement à risque d'explosion. Ils sont pourvus de piquages avec joint pour un raccordement direct sur conduits d'air circulaires. Les ventilateurs centrifuges utilisés dans les caissons AKU sont équipés moto-ventilateurs à rotor extérieur, ne nécessitant pas d'entretien. Les moteurs possèdent une protection thermique à réarmement automatique. Les ventilateurs avec bornes TK-TK intègrent une protection du moteur par thermocontact. L'entretien et la maintenance des ventilateurs sont facilités grâce au panneau d'ouverture sur charnières. C'est pourquoi il est facile d'entretenir les ventilateurs. Le courant maximal et la puissance des moteurs sont indiqués près de la tension d'alimentation nominale. La variation de vitesse peut se faire par variation de tension. A cet égard, nous recommandons pour chaque ventilateur les régulateurs de vitesses adéquates. Les caissons AKU sont exclusivement prévus pour un montage intérieur.



Канальные акустические вентиляторы изготавливаются из оцинкованной жести. Корпус вентиляторов имеет 50 мм слой термической и акустической изоляции. Данные изделия не могут работать во взрывоопасной среде. Эксплуатируются в целях подачи и вытяжки чистого воздуха. Монтируются в системы круглых воздуховодов. В вентиляторах AKU используется центробежные вентиляторы, подшипники двигателей которые не требуют ухода. Двигатели оснащены автоматической теплозащитой. Вентиляторы с клеммами ТК имеют встроенную термоконтактную защиту двигателя. Обзорная крышка вентилятора открывается легко, что обеспечивает удобное обслуживание. Максимальный ток двигателя указан рядом с номинальным напряжением питания. При снижении напряжения ток двигателя может превысить указанное значение. Поэтому для каждого вентилятора рекомендуем соответствующие регуляторы скоростей. Акустические вентиляторы монтируются только в закрытых помещениях.

## Accessories

Single phase speed controller	Monophase speed controller	Mounting clamp	Guard grille	Back draft shutter	Circular duct silencer
					
TGRV p. 84	MTY p. 87	AP p. 98	AGO p. 158	RSK p. 151	AKS p. 144

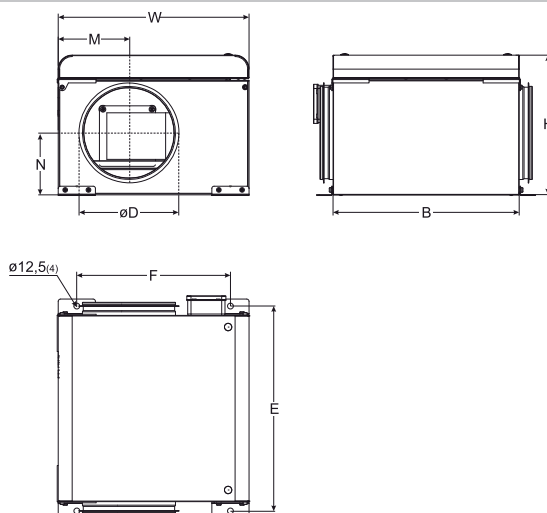

Type	Dimensions [mm]							
	B	W	H	M	N	øD	E	F
AKU 125 M	400	410	300	133	171,5	125	440	330
AKU 125 D	400	410	300	133	171,5	125	440	330
AKU 160 M	400	410	300	261,5	141	160	440	330
AKU 160 D	400	410	300	261,5	141	160	440	330
AKU 200 M	444	444	420	222	250	200	484	364
AKU 200 D	400	410	300	258	133	200	440	330
AKU 200 S	600	560	420	170	244,5	200	640	480
AKU 250 M	444	444	420	222	221,5	250	484	364
AKU 250 D	694	694	500	218	304	250	734	614
AKU 250 S	694	694	500	228	304	250	734	614
AKU 315 M	694	694	500	238	270	315	734	614
AKU 315 D	768	768	570	238	319,5	315	808	688
AKU 400 D	768	768	570	252	304,5	400	808	688
AKU 400 S	705	768	685	384	420	400	745	688

Type	Accessories										
	TGRV	MTY	AP	AGO	RSK	AKS	FD	FDI	EKA	AVS	AVA
AKU 125 M	1,5	0,5	125	125	125	125	125	125	125	125	125
AKU 125 D	1,5	1,5	125	125	125	125	125	125	125	125	125
AKU 160 M	1,5	1,5	160	160	160	160	160	160	160	160	160
AKU 160 D	1,5	1,5	160	160	160	160	160	160	160	160	160
AKU 200 M	1,5	1,5	200	200	200	200	200	200	200	200	200
AKU 200 D	1,5	1,5	200	200	200	200	200	200	200	200	200
AKU 200 S	1,5	1,5	200	200	200	200	200	200	200	200	200
AKU 250 M	2	1,5	250	250	250	250	250	250	250	250	250
AKU 250 D	4	4	250	250	250	250	250	250	250	250	250
AKU 250 S	2	1,5	250	250	250	250	250	250	250	250	250
AKU 315 M	7	-	315	315	315	315	315	315	315	315	315
AKU 315 D	11	-	315	315	315	315	315	315	315	315	315
AKU 400 D	11	-	400	400	400	400	400	400	400	400	400
AKU 400 S	11	-	400	400	400	400	400	400	400	400	400

## Accessories



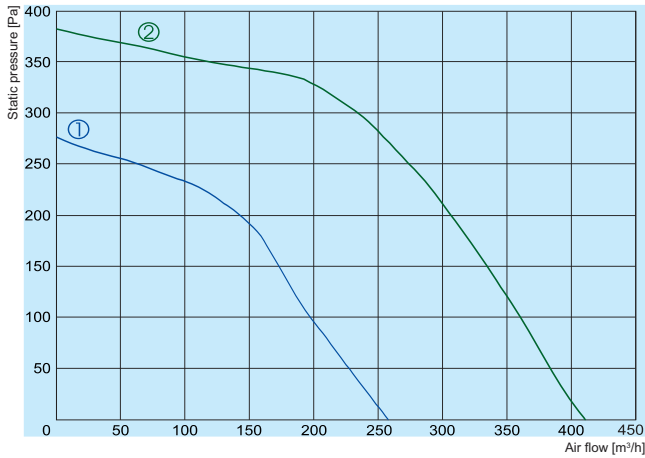

① — AKU 125 M  
 ② — AKU 125 D

		AKU 125 M	AKU 125 D
Voltage/Frequency	[V/Hz]	~1, 230	~1, 230
Power consumption	[kW]	0,075	0,120
Current	[A]	0,33	0,53
Speed	[min <sup>-1</sup> ]	2335	2480
Max. airflow	[m³/h]	258	411
Max. air temperature	[°C]	55	65
Total sound pressure level at 1 m	[dBA]	35	38
Weight	[kg]	12,0	13,0
Wiring diagram		No. 2	No. 1
Protection class:	motor	IP-44	IP-44
	terminal box	IP-55	IP-55
Impeller		forward curved	forward curved
Inlet		single	single

### 125 M

	L <sub>pa</sub> dB(A)	L <sub>wa</sub> total dB(A)	L <sub>wa</sub> , dB(A)								
			63 Hz	125 Hz	250 Hz	500 Hz	1 kHz	2 kHz	4 kHz	8 kHz	16 kHz
Inlet	48	55	40	48	43	48	50	43	44	37	22
Outlet	60	67	36	47	52	57	64	62	56	48	33

Measured at 168 m³/h, 137 Pa

### 125 D

	L <sub>pa</sub> dB(A)	L <sub>wa</sub> total dB(A)	L <sub>wa</sub> , dB(A)								
			63 Hz	125 Hz	250 Hz	500 Hz	1 kHz	2 kHz	4 kHz	8 kHz	16 kHz
Inlet	54	61	46	56	50	55	52	52	51	47	37
Outlet	67	74	42	53	56	63	70	69	65	60	51

Measured at 290 m³/h, 142 Pa

The fan characteristic curves were determined in accordance with DIN 24163 resp. ISO 5801. The sound levels were determined in accordance with DIN 45635 resp. ISO 3744 at a distance of 1 m from the fan

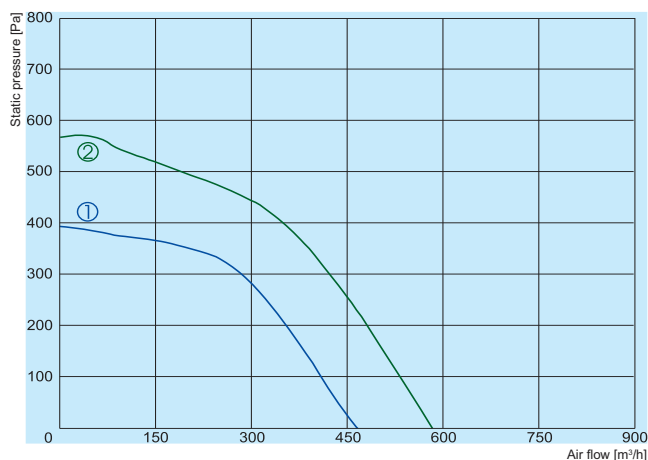

① — AKU 160 M  
② — AKU 160 D

		AKU 160 M	AKU 160 D
Voltage/Frequency	[V/Hz]	~1, 230	~1, 230
Power consumption	[kW]	0,135	0,215
Current	[A]	0,59	0,93
Speed	[min <sup>-1</sup> ]	2480	2130
Max. airflow	[m <sup>3</sup> /h]	465	583
Max. air temperature	[°C]	65	65
Total sound pressure level at 1 m	[dBA]	38	41
Weight	[kg]	13,0	14,0
Wiring diagram		No. 1	No. 1
Protection class:	motor	IP-44	IP-44
	terminal box	IP-55	IP-55
Impeller		forward curved	forward curved
Inlet		single	single

### 160 M

	L <sub>pa</sub> dB(A)	L <sub>wa</sub> total dB(A)	L <sub>wa</sub> , dB(A)								
			63 Hz	125 Hz	250 Hz	500 Hz	1 kHz	2 kHz	4 kHz	8 kHz	16 kHz
Inlet	59	66	48	58	57	59	55	56	58	54	44
Outlet	69	76	43	55	62	66	72	71	67	64	55

Measured at 361 m<sup>3</sup>/h, 137 Pa

### 160 D

	L <sub>pa</sub> dB(A)	L <sub>wa</sub> total dB(A)	L <sub>wa</sub> , dB(A)								
			63 Hz	125 Hz	250 Hz	500 Hz	1 kHz	2 kHz	4 kHz	8 kHz	16 kHz
Inlet	60	67	49	59	56	61	58	58	59	55	44
Outlet	72	79	46	57	61	70	75	75	69	66	54

Measured at 483 m<sup>3</sup>/h, 150 Pa

The fan characteristic curves were determined in accordance with DIN 24163 resp. ISO 5801. The sound levels were determined in accordance with DIN 45635 resp. ISO 3744 at a distance of 1 m from the fan

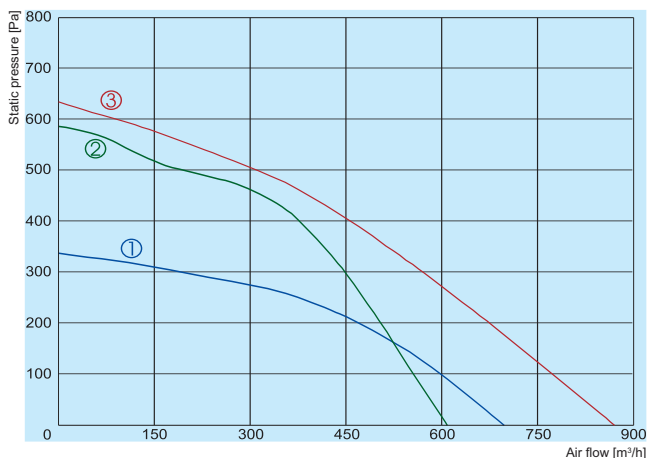

- ① — AKU 200 M
- ② — AKU 200 D
- ③ — AKU 200 S

		AKU 200 M	AKU 200 D	AKU 200 S
Voltage/Frequency	[V/Hz]	~1, 230	~1, 230	~1, 230
Power consumption	[kW]	0,167	0,239	0,145
Current	[A]	0,72	1,04	0,64
Speed	[min <sup>-1</sup> ]	1550	2130	2510
Max. airflow	[m³/h]	697	611	870
Max. air temperature	[°C]	55	65	75
Total sound pressure level at 1 m	[dBA]	40	46	50
Weight	[kg]	17,0	13,0	26,0
Wiring diagram		No. 1	No. 1	No. 1
Protection class:	motor	IP-44	IP-44	IP-44
	terminal box	IP-55	IP-55	IP-55
Impeller		forward curved	forward curved	backwards curved
Inlet		double	single	single

### 200 M

	L <sub>pa</sub> dB(A)	L <sub>wa</sub> total dB(A)	L <sub>wa</sub> , dB(A)								
			63 Hz	125 Hz	250 Hz	500 Hz	1 kHz	2 kHz	4 kHz	8 kHz	16 kHz
Inlet	56	63	49	57	50	55	56	55	54	50	37
Outlet	67	74	43	56	58	62	69	68	66	61	46

Measured at 519 m³/h, 121 Pa

### 200 D

	L <sub>pa</sub> dB(A)	L <sub>wa</sub> total dB(A)	L <sub>wa</sub> , dB(A)								
			63 Hz	125 Hz	250 Hz	500 Hz	1 kHz	2 kHz	4 kHz	8 kHz	16 kHz
Inlet	62	69	48	59	60	62	62	62	61	57	46
Outlet	71	78	44	55	63	69	74	72	70	66	55

Measured at 502 m³/h, 174 Pa

### 200 S

	L <sub>pa</sub> dB(A)	L <sub>wa</sub> total dB(A)	L <sub>wa</sub> , dB(A)								
			63 Hz	125 Hz	250 Hz	500 Hz	1 kHz	2 kHz	4 kHz	8 kHz	16 kHz
Inlet	58	65	50	54	61	57	54	52	53	52	36
Outlet	73	80	48	56	66	77	74	72	67	63	48

Measured at 755 m³/h, 171 Pa

The fan characteristic curves were determined in accordance with DIN 24163 resp. ISO 5801. The sound levels were determined in accordance with DIN 45635 resp. ISO 3744 at a distance of 1 m from the fan

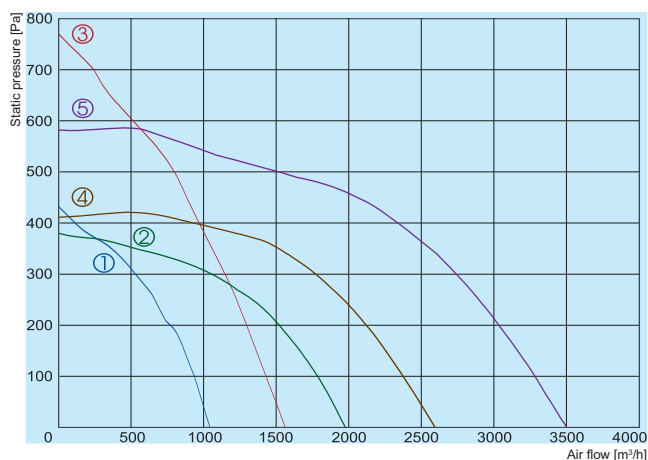

- ① AKU 250 M
- ② AKU 250 D
- ③ AKU 250 S
- ④ AKU 315 M
- ⑤ AKU 315 D

		AKU 250 M	AKU 250 D	AKU 250 S	AKU 315 M	AKU 315 D
Voltage/Frequency	[V/Hz]	~1, 230	~1, 230	~1, 230	~1, 230	~1, 230
Power consumption	[kW]	0,265	0,545	0,310	0,950	1,505
Current	[A]	1,15	2,56	1,35	4,79	6,61
Speed	[min <sup>-1</sup> ]	2082	1190	2665	1210	1290
Max. airflow	[m³/h]	1045	1976	1563	2596	3499
Max. air temperature	[°C]	40	40	60	40	40
Total sound pressure level at 1 m	[dBA]	51	49	51	53	60
Weight	[kg]	18,0	39,0	37,0	47,0	63,0
Wiring diagram		No. 2	No. 3	No. 2	No. 3	No. 3
Protection class:	motor	IP-44	IP-54	IP-44	IP-54	IP-54
	terminal box	IP-55	IP-55	IP-55	IP-55	IP-55
Impeller		forward curved	forward curved	backwards curved	forward curved	forward curved
Inlet		double	single	single	single	single

### 250 M

	L <sub>pa</sub> dB(A)	L <sub>wa</sub> total dB(A)	L <sub>wa</sub> , dB(A)								
			63 Hz	125 Hz	250 Hz	500 Hz	1 kHz	2 kHz	4 kHz	8 kHz	16 kHz
Inlet	63	70	55	61	60	60	58	66	59	53	43
Outlet	75	82	49	59	64	70	72	80	70	65	54

Measured at 899 m³/h, 131 Pa

### 250 D

	L <sub>pa</sub> dB(A)	L <sub>wa</sub> total dB(A)	L <sub>wa</sub> , dB(A)								
			63 Hz	125 Hz	250 Hz	500 Hz	1 kHz	2 kHz	4 kHz	8 kHz	16 kHz
Inlet	58	65	56	58	59	54	57	55	56	50	37
Outlet	72	79	49	59	65	73	75	71	71	63	50

Measured at 1340 m³/h, 152 Pa

### 250 S

	L <sub>pa</sub> dB(A)	L <sub>wa</sub> total dB(A)	L <sub>wa</sub> , dB(A)								
			63 Hz	125 Hz	250 Hz	500 Hz	1 kHz	2 kHz	4 kHz	8 kHz	16 kHz
Inlet	61	68	56	56	65	58	59	57	56	55	38
Outlet	74	81	51	67	73	77	75	72	69	64	47

Measured at 1100 m³/h, 174 Pa

### 315 M

	L <sub>pa</sub> dB(A)	L <sub>wa</sub> total dB(A)	L <sub>wa</sub> , dB(A)								
			63 Hz	125 Hz	250 Hz	500 Hz	1 kHz	2 kHz	4 kHz	8 kHz	16 kHz
Inlet	64	71	61	66	66	59	60	61	60	54	42
Outlet	75	82	52	65	71	78	77	73	74	65	53

Measured at 1930 m³/h, 119 Pa

### 315 D

	L <sub>pa</sub> dB(A)	L <sub>wa</sub> total dB(A)	L <sub>wa</sub> , dB(A)								
			63 Hz	125 Hz	250 Hz	500 Hz	1 kHz	2 kHz	4 kHz	8 kHz	16 kHz
Inlet	66	73	62	65	67	61	65	64	64	58	47
Outlet	80	87	57	67	75	82	82	79	79	71	60

Measured at 2617 m³/h, 174 Pa

The fan characteristic curves were determined in accordance with DIN 24163 resp. ISO 5801. The sound levels were determined in accordance with DIN 45635 resp. ISO 3744 at a distance of 1 m from the fan

# AKU

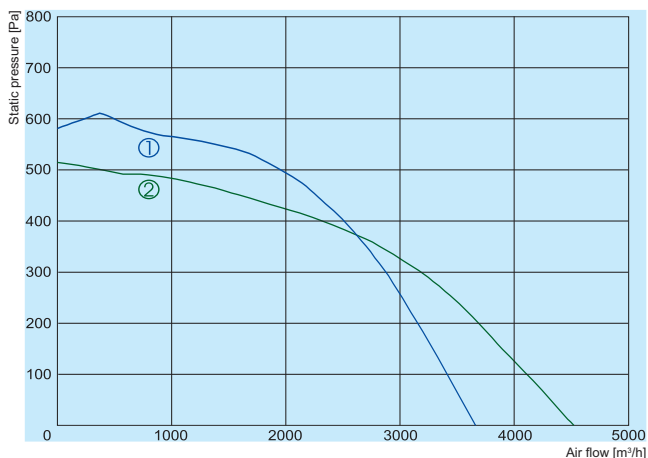

① AKU 400 D  
② AKU 400 S

		AKU 400 D	AKU 400 S
Voltage/Frequency	[V/Hz]	~1, 230	~1, 230
Power consumption	[kW]	1,720	1,474
Current	[A]	7,63	6,49
Speed	[min <sup>-1</sup> ]	1290	1150
Max. airflow	[m³/h]	3664	4521
Max. air temperature	[°C]	40	40
Total sound pressure level at 1 m	[dBA]	60	69
Weight	[kg]	63,0	70,0
Wiring diagram		No. 3	No. 4
Protection class:	motor	IP-54	IP-54
	terminal box	IP-55	IP-55
Impeller		forward curved	forward curved
Inlet		single	double

## 400 D

	L <sub>pa</sub> dB(A)	L <sub>wa</sub> total dB(A)	L <sub>wa</sub> , dB(A)								
			63 Hz	125 Hz	250 Hz	500 Hz	1 kHz	2 kHz	4 kHz	8 kHz	16 kHz
Inlet	69	76	66	69	69	64	69	69	67	63	52
Outlet	82	89	59	70	78	84	83	82	81	75	64

Measured at 3040 m³/h, 169 Pa

The fan characteristic curves were determined in accordance with DIN 24163 resp. ISO 5801. The sound levels were determined in accordance with DIN 45635 resp. ISO 3744 at a distance of 1 m from the fan

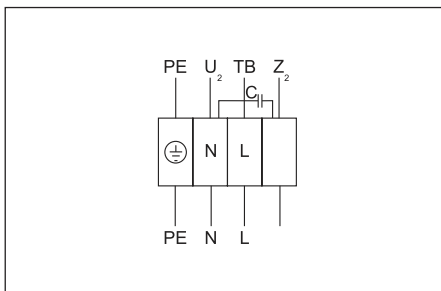

**Wiring diagram No. 1 (1~230V)**

PE - yellow-green  
 U<sub>2</sub> - blue  
 Z<sub>2</sub> - black  
 TB - brown

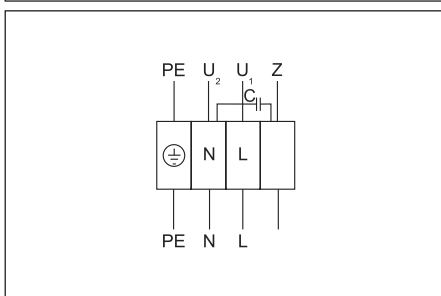

**Wiring diagram No. 2 (1~230V)**

PE - yellow-green  
 U<sub>2</sub> - black  
 U<sub>1</sub> - blue  
 Z - brown

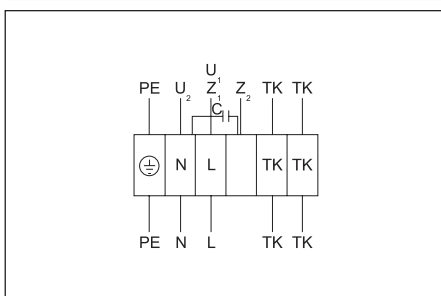

**Wiring diagram No. 3 (1~230V)**

PE - yellow-green  
 U<sub>1</sub> - brown  
 U<sub>2</sub> - blue  
 Z<sub>1</sub> - black  
 Z<sub>2</sub> - orange  
 TK - white

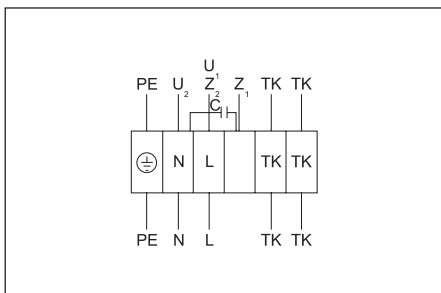

**Wiring diagram No. 4 (1~230V)**

PE - yellow-green  
 U<sub>1</sub> - brown  
 U<sub>2</sub> - blue  
 Z<sub>1</sub> - black  
 Z<sub>2</sub> - orange  
 TK - white